

# 940系列模块化喷嘴 Module System Range 940



## 可选材质

- 耐酸不锈钢
- 耐酸不锈钢
- 黄铜
- 钽金属
- 钛合金
- 哈氏合金
- 铬镍铁合金
- 聚氯乙烯
- 聚四氟乙烯
- PP聚丙烯
- 客户指定材质

## Materials

- Acid resistant stainless steel
- Heat resistant stainless steel
- Brass
- Tantalum
- Titanium
- Hastelloy
- Inconel
- PVC
- PTFE
- Polypropylene
- Custom materials available on request

应用极为灵活，适用于标准风帽和扁喷风帽，不借助工具就能快速更换。

*Extremely flexible to use; the standard air cap and flat spray cap can be quickly and simply changed by hand*

喷嘴组件模块化有助于应用在各种场合，确保雾化效果的一致性。

*The modular system allows for a very diverse range of application options and ensures reproducible results*

● 关键部件的表面粗糙度小于0.8  
(而且设计符合FDA认证)

Functional components with a surface quality of  $Ra < 0.8$  (also available as designs conforming to FDA)

● 雾化十分均匀、一致性极好

Completely homogeneous and reproducible spray results

# 施利克经典喷嘴系列

## 为雾化技术而生

产品目录  
Product Overview

两液体喷嘴  
Two-Substance  
Nozzles

防滴漏/专业包浆技术  
ABC/PCA Technique

三/四液体喷嘴  
Three-/Four-

多头技术  
Multispray

喷嘴杆  
Insertion Pipes

喷嘴头  
Nozzle Heads

实心锥喷嘴  
Full Cone Nozzles

空心锥喷嘴  
Hollow Cone Nozzles

硬质合金喷嘴  
Carbide Nozzles

扁平喷嘴  
Flat Spray Nozzles

喷射喷嘴  
Smooth-Jet Nozzles

混合喷嘴  
Mixing Nozzles

拉瓦尔喷嘴  
Laval Nozzles

清洗喷嘴  
Cleaning Nozzles

喷嘴附件  
Accessories

测试中心  
Test Center

# 940系列模块化喷嘴

## Module System Range 940

Mod. 940

双流体喷嘴/全锥形/外混型

Two-Substance Nozzles / Full-Cone / External Mixing

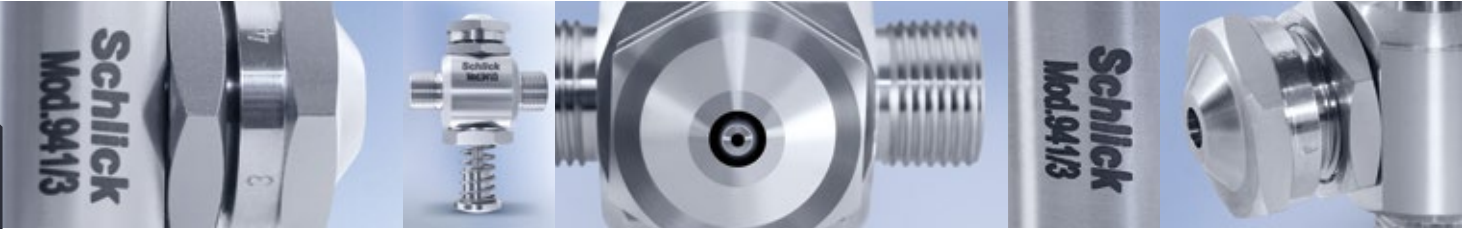

### 全方位的， 几乎能用于所有雾化场合

940系列喷嘴，可采用压缩空气、煤气、蒸汽进行雾化(0.5bar以上)，雾化面积大

基于液体的粘度、密度和表面张力，液体可采用真空吸入也可通过压力泵入，某些情况下，此系列喷嘴也可用作喷射喷嘴

外混型二流体喷嘴，可以单独控制流量大小和雾化液滴大小。

此系列喷嘴，流量大小基本都是通过压力差控制的。在带有针阀的喷嘴型号，流量也可以通过针阀的调节来调节

此系列喷嘴全部采用模块化结构。这意味着它可以很容易地改造成其他型号的喷嘴。而且每个零件都可单独更换，不影响雾化效果。

### The all-rounder, our nozzle for nearly all applications

With the SCHLICK model range 940, the liquid is applied to a specific large surface using compressed air, gas or steam – from 0.5 bar (g).







Depending on the viscosity, density and surface tension, the liquid can be aspirated over a gradient or fed under pressure. Within certain limits, the nozzles can also act as injectors.

External-mix two-substance nozzles allow independent control of the flow rate and fineness of the atomization.

The flow rate for all models is controlled through the liquid pressure difference. In the model with a regulating pin, the flow rate can also be regulated by the pin setting.

The SCHLICK model 940 is manufactured as a modular construction. This means that it can easily be rebuilt into other designs. Replacement parts are available for all individual parts, with reproducible results ensured.

	雾化形状 (标准风帽) 实心圆锥形
	雾化形状 (扁喷风帽) 扁平椭圆形
	雾化角度 (标准风帽): 大致 10-40° 雾化角度 (扁喷风帽): 最大 70°
	液滴大小 10 - 150 µm
	处理量 0,05 - 3,0 l/min
	标准喷嘴孔径 0,5 / 0,8 / 1,0 / 1,2 / 1,5 / 1,8 / 2,0 / 2,2 mm 最小孔径0.3mm, 后面按0.1mm或者按其整数倍增加均可

	<b>Spray pattern (standard air cap):</b> circular full-cone
	<b>Spray pattern (flat spray cap):</b> oval flat spray
	<b>Spray angle (standard air cap):</b> approx. 10° - 40° <b>Spray angle (flat spray cap):</b> max. 70°
	<b>Droplet size:</b> 10 - 150 µm
	<b>Capacity:</b> 0.05 - 3.0 l/min
	<b>Standard orifices:</b> 0.5 / 0.8 / 1.0 / 1.2 / 1.5 / 1.8 / 2.0 / 2.2 mm Customized bore sizes are possible starting from 0.3 mm upwards in 0.1 mm steps

**创新性产品设计**

- 安装拆卸非常简单
- 显著减少维修时间
- 多种安装方式可选
- 终身售后服务保障
- 免费产品设计和技术支持

**Innovative product design**

- Extremely easy to adjust for maximum flexibility
- Significant reduction in maintenance downtimes thanks to easy access to all components
- Wide range of installation options thanks to modular construction
- Long-term after-sales warranty
- Engineering free of charge



通过调整风帽位置，雾化角度可在10°~40°之间调节

将风帽向后旋，雾化气流量变小雾化角度变小；  
将风帽向前旋，雾化气流量变大雾化角度变大

根据实际应用，  
通过调试来确定风帽位置

风帽处于位置0 = 无雾化气，喷嘴关闭  
风帽处于位置5 = 正常设置

The scatter cone can be set between 10° and 40° through adjustment of the air cap position.

By turning the air cap backwards, the air flow rate is reduced and the scatter cone becomes more focused. By turning the air cap forwards, the air flow rate and scatter cone become larger.

Depending on the intended use, the required cap setting must be determined through trial and error.

Cap setting 0 = nozzle closed  
Cap setting 5 = normal setting



940系列喷嘴均可选用加长喷芯，有利于粘性液体的雾化以及最大程度减少喷嘴处的结须。

All nozzle forms can also be delivered with extended liquid inserts. These optimise the atomization of tacky liquids and minimise build-up at the air expulsion hole.

# 940系列模块化喷嘴 Module System Range 940

Mod. 940

双流体喷嘴/全锥形/外混型  
Two-Substance Nozzles / Full-Cone / External Mixing

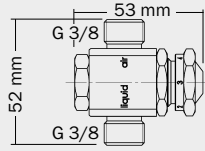

盲堵堵  
Blind plug

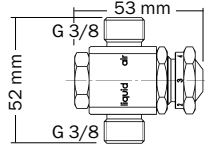

带涡流杆盲堵  
Blind plug and swirl chamber

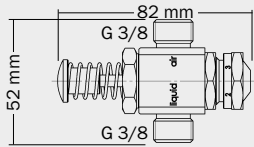

防堵通针  
Cleaning needle

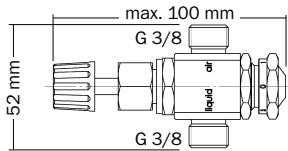
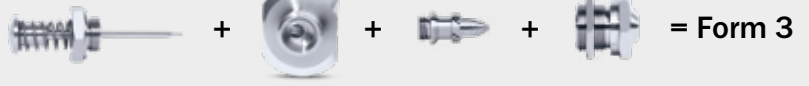

流量调节针阀  
Liquid flow control needle

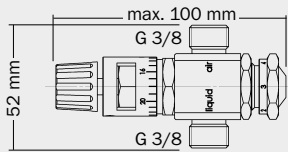
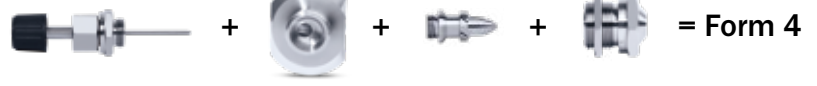

带刻度流量调节针阀  
Scale

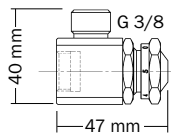

液体从中心进料  
Central liquid feed

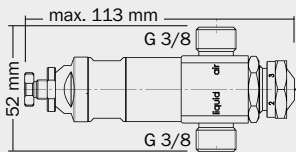

100% 无滴漏  
drip-free

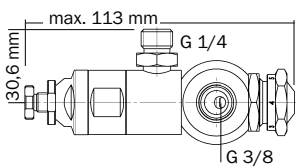
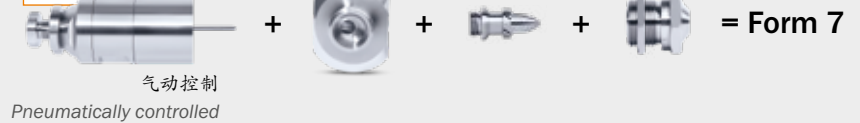

单独控制气控制  
Pneumatically controlled by control air

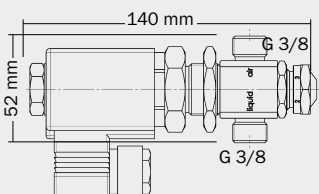

100% 无滴漏  
drip-free



采用盲堵设计的基本款，用于吸入或者重力差供液的雾化场合

*Basic model with dummy plug. Designed for the atomisation of liquids that are either siphoned or fed by gravity at a slight gradient.*

采用涡流杆设计，用于需要液滴比较小的雾化场合，特别适用于纺织品的湿润

*Dummy plug with swirl chamber. Designed for fine atomisation of liquids under pressure. Especially suitable for integration in textile web moisturising equipment.*

采用防堵通针设计，生产过程中就能实现快速疏通喷芯，用于高粘度或者有杂质的液体雾化场合 采用清洁通针设计，生产过程中就能实现快速疏通喷芯，用于高粘度或者有杂质的液体雾化场合

*Supplied with cleaning needle. For fast nozzle orifice cleaning during operation. Designed for the atomisation of sticky, impure, or highly viscous liquids, etc.*

采用流量调节针阀，用于流量大小需要经常调节的场合

*Supplied with a liquid flow control needle for atomising tasks having highly variable flow rates.*

和设计4类似，增加了刻度显示，可精准设置流量，用于测试、实验室等场合。

*As Form 4, but with a scale etched on the liquid control needle for fine setting of the flow rate, designed for experiments, laboratories, etc.*

采用液体从中心送料，用于高粘性溶液、浆料等的雾化。

*With straight (central) liquid feed, for atomisation of highly viscous solutions, pastes, etc.*

使用雾化气控制针阀，当雾化气关闭时，针阀顶出(也可换成清洁通针)，封闭喷芯，适用于避免滴液的雾化场合，比如蚀刻、标记、连续喷涂等。

*Pneumatically controlled using the atomising air. The nozzle needle (also available as cleaning needle) closes the orifice automatically and abruptly when the atomising air is shut off. Especially suitable for etching, marking, cyclic spraying and above all for liquids under pressure where drips are to be avoided.*

和设计7类似，增加了单独的控制气控制针阀(雾化气可不关闭)

*As Form 7, but with control by control air, with special connector (atomising air can carry on blowing).*

电磁阀控制  
 标准设计: 230V 50Hz; 环境温度 (100%使用): 最大55°C;  
 防水等级: IP65; 循环频率仅受转换时间的限制

*With solenoid valve  
 Standard design: 230 V, 50 Hz, 100 % ED  
 Ambient temperature: max. 55 °C, enclosure protection IP 65  
 Cycling frequency limited only by the changeover time*

myschlick.com

# 940系列模块化喷嘴 Module System Range 940

Mod. 940

双流体喷嘴/全锥形/外混型  
Two-Substance Nozzles / Full-Cone / External Mixing



如有技术变更,恕不另行通知。

## 应用

- 空气调节装置
- 包衣
- 燃烧
- 消毒
- 精整
- 流化床技术
- 制粒
- 混合
- 脱硫脱硝
- 工艺工程
- 修复
- 喷雾干燥
- 烟草工业

## Applications

- Air conditioning
- Coating
- Combustion
- Disinfecting
- Finishing
- Fluid bed technology
- Granulating
- Mixing
- No<sub>x</sub>-Reduction  
(SCR-/SNCR-technologies)
- Process engineering
- Recovery
- Spray drying
- Tobacco industry  
(casing, flavouring)

产品目录  
Product Overview

两液体喷嘴  
Two-Substance  
Nozzles

防滴漏/专业包衣技术  
ABC/PCA Technique

三/四液体喷嘴  
Three-/Four-

多喷头技术  
Multispray

喷嘴杆  
Insertion Pipes

喷嘴头  
Nozzle Heads

空心锥喷嘴  
Full Cone Nozzles

空心锥喷嘴  
Hollow-Cone Nozzles

硬质合金喷嘴  
Carbide Nozzles

扁平喷嘴  
Flat Spray Nozzles

喷射喷嘴  
Smooth-Jet Nozzles

混合喷嘴  
Mixing Nozzles

拉瓦尔喷嘴  
Laval Nozzles

清洗喷嘴  
Cleaning Nozzles

喷嘴附件  
Accessories

测试中心  
Test Center



# 具体技术参数 Technical Details



## 940系列喷嘴性能参数 Performance specification of model 940

型号 Model	喷嘴孔径 (mm) Bore diameter liquid insert in mm	雾化气压力 (bar) Atomising air pressure in bar	雾化气的消耗量 (立方/小时) Atomising air consumption in Normal m <sup>3</sup> /h	不同高度下的液体虹吸流 量 升/分钟 (设计形式1) Max. siphon volume in l/min, Form 0, siphon height in mm			不同高度下的液体虹吸流 量 升/分钟 (设计形式3-8) Max. siphon volume in l/min, Form 3-8, siphon height in mm			风帽最佳设定 位置 Best air cap setting
				50	150	300	50	150	300	
940	0.8	0.3	2.1	0.080	0.060	0.040	0.060	0.045	0.030	2
		0.5	4.0	0.100	0.080	0.050	0.075	0.060	0.035	3
		1.0	6.4	0.125	0.110	0.090	0.100	0.085	0.070	3
		1.5	8.2	0.150	0.125	0.110	0.115	0.100	0.085	4
941	1.2	0.3	2.0	0.140	0.110	0.060	0.105	0.085	0.045	3
		0.5	4.0	0.175	0.150	0.110	0.130	0.115	0.085	3
		1.0	7.4	0.220	0.190	0.160	0.165	0.140	0.120	4
		1.5	10.2	0.250	0.220	0.185	0.190	0.165	0.140	5
942	1.8	0.3	2.9	0.180	0.125	0.070	0.135	0.100	0.050	3
		0.5	4.7	0.280	0.220	0.140	0.210	0.165	0.105	4
		1.0	8.2	0.380	0.330	0.250	0.280	0.250	0.190	5
		1.5	11.5	0.500	0.400	0.300	0.380	0.300	0.220	1-2
943	2.3	0.3	2.9	0.260	0.175	0.085	0.200	0.130	0.065	3
		0.5	4.7	0.370	0.270	0.170	0.280	0.200	0.130	4
		1.0	8.2	0.500	0.400	0.290	0.280	0.300	0.210	5
		1.5	11.5	0.550	0.450	0.380	0.410	0.340	0.220	1-2

## 940系列 (设计形式0) 喷嘴性能参数, 风帽处于标准位置 Performance specification of model 940 (form 0), standard cap setting

雾化气压力 (bar) Atomising air pressure in bar	雾化气的消 耗量 (立方/小时) Atomising air consumption in Normal m <sup>3</sup> /h	最大处理量 (以水为例, 升/小时) Max. water flow rate l/h	空气和水 的重量比 kg air/ kg water
1	7.0	15	0.55
2	11.0	30	0.44
3	14.9	40	0.44
4	19.4	55	0.42
5	22.5	70	0.38
6	27.6	95	0.34

这里的最大流量, 是指确保液滴平均大小在50微米以下的情况下的最大流量。

The values describe the maximum flow rates at which a fine atomisation with a mean volume droplet size of 50 microns is ensured.

## 940系列喷嘴的雾化 Spray model 940



信任和质量是合作成功的基础，  
这不仅仅指我们的产品，  
也适用于我们的服务。  
如有需要，我们可向您提供喷嘴相关文件，  
如技术手册(包括图纸、流量图、安装和操作说明)  
、SCHLICK 的公司相关证书以及喷嘴的材质说明。

Reliability and quality are the basis for successful cooperation. This applies both to our products and to our service. If you wish, we will supply you with all necessary documentation such as technical handbooks for the nozzles (drawings, flow diagrams, installation and operating instructions) together with factory and material specifications.



产品目录  
Product Overview

两液体喷嘴  
Two-Substance  
Nozzles

防飞溅/零飞溅材料技术  
ABC/PCA Technique

三/四液体喷嘴  
Three-/Four-

多喷头技术  
Multispray

喷嘴杆  
Insertion Pipes

喷嘴头  
Nozzle Heads

空心锥喷嘴  
Full-Cone Nozzles

空心锥喷嘴  
Hollow-Cone Nozzles

硬质合金喷嘴  
Carbide Nozzles

扁平喷嘴  
Flat-Spray Nozzles

喷射喷嘴  
Smooth-Jet Nozzles

混合喷嘴  
Mixing Nozzles

拉瓦尔喷嘴  
Laval Nozzles

清洗喷嘴  
Cleaning Nozzles

喷嘴附件  
Accessories

测试中心  
Test Center

# 具体技术参数 Technical Details



Mod. 940

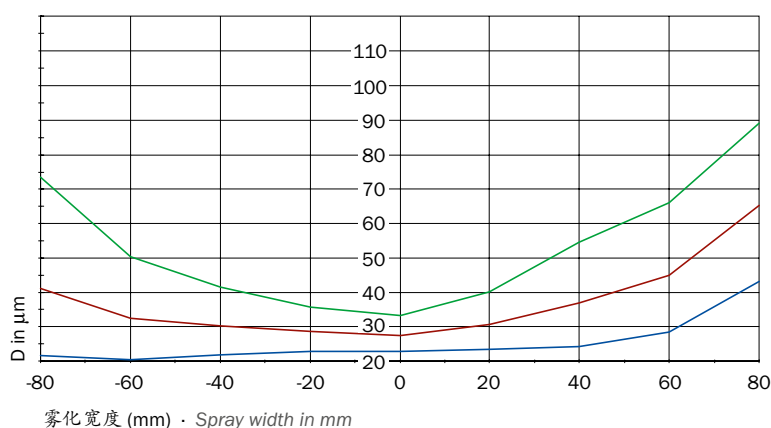

■ D10 ■ D30 ■ D32

**941/0型喷嘴的液滴大小**  
 雾化宽度: 160mm, 距离: 200mm  
 液体流量: 30升/小时  
 雾化空气消耗量: 11立方/小时  
 雾化空气压力: 2bar

**Droplet size of Mod. 941/0**  
 Spray width: 160 mm, distance: 200 mm,  
 liquid throughput: 30 l/h,  
 atomization air consumption: 11,0 Nm<sup>3</sup>/h,  
 atomization air pressure: 2.0 bar (g)

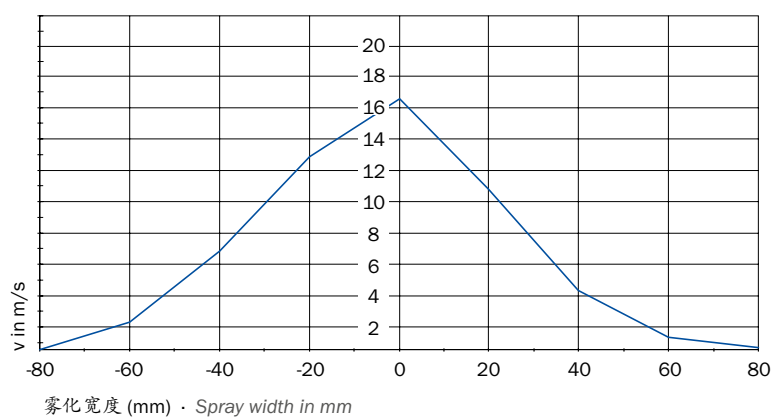

**941/0型喷嘴的雾化速度**  
 雾化宽度: 160mm, 距离: 200mm  
 液体流量: 30升/小时  
 雾化空气消耗量: 11立方/小时  
 雾化空气压力: 2bar

**Velocities of Mod. 941/0**  
 Spray width: 160 mm, distance: 200 mm,  
 liquid throughput: 30 l/h,  
 atomization air consumption: 11,0 Nm<sup>3</sup>/h,  
 atomization air pressure: 2.0 bar (g)

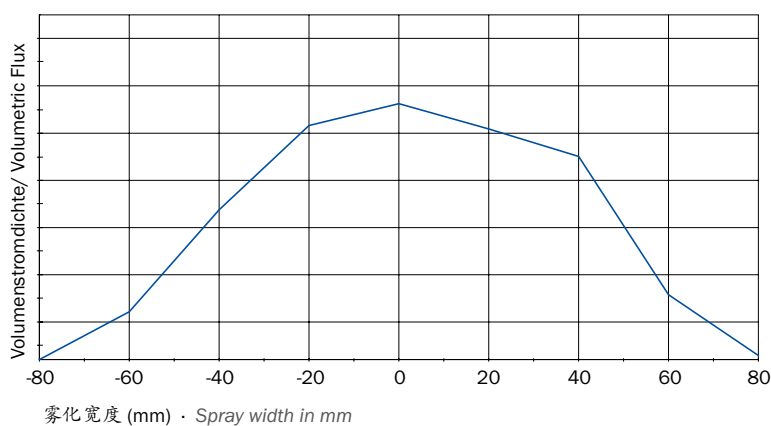

**941/0型喷嘴雾化体积密度**  
 雾化宽度: 160mm, 距离: 200mm  
 液体流量: 30升/小时  
 雾化空气消耗量: 11立方/小时  
 雾化空气压力: 2bar

**Volume density of Mod. 941/0**  
 Spray width: 160 mm, distance: 200 mm,  
 liquid throughput: 30 l/h,  
 atomization air consumption: 11,0 Nm<sup>3</sup>/h,  
 atomization air pressure: 2.0 bar (g)

如有技术变更, 恕不另行通知。

相位多普勒测量技术  
- 雾化效果可测量

SCHLICK 测量系统采用双相位激光多普勒测试原理 (5瓦氩离子激光器), 能精准测量雾化液滴颗粒参数和其流体特性

PDA measurement technology –  
measurable success

SCHLICK uses a drop measurement device designed according to the dual PDA principle (Phase-Doppler Anemometry), with a 5-watt (argon-ionic) continuous wave laser.

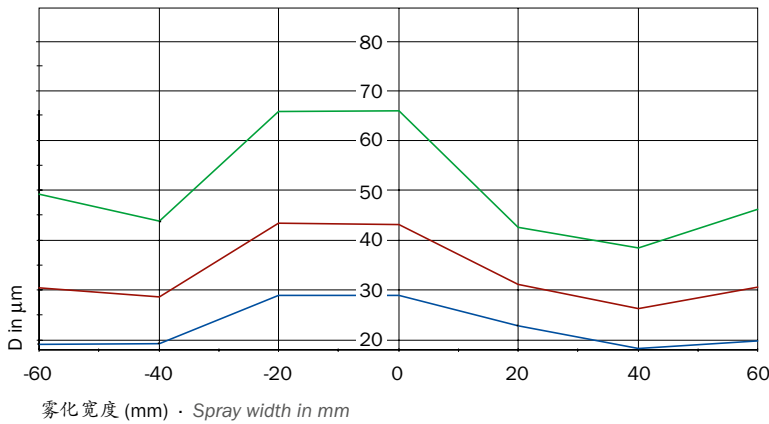

■ D10 ■ D30 ■ D32

**943/0型喷嘴的雾化的液滴大小**  
 雾化宽度: 120mm, 距离: 200mm  
 液体流量: 70升/小时, 流体压力差: 0.1bar  
 雾化空气消耗量: 22.5立方/小时  
 雾化空气压力: 5bar

**Droplet size of Mod. 943/0**

Spray width: 120 mm, distance: 200 mm,  
 liquid throughput: 70 l/h, liquid pressure: 0.1 bar ( $\Delta p$ )  
 atomization air consumption: 22.5 Nm<sup>3</sup>/h,  
 atomization air pressure: 5.0 bar (g)

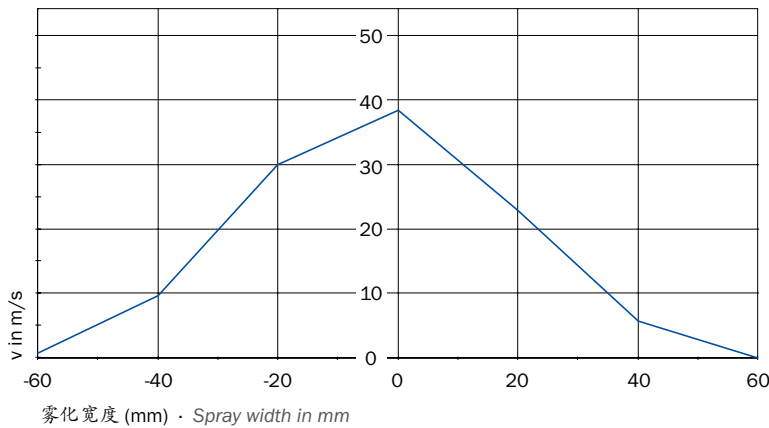

**Velocities of Mod. 943/0**

Spray width: 120 mm, distance: 200 mm,  
 liquid throughput: 70 l/h, liquid pressure: 0.1 bar ( $\Delta p$ )  
 atomization air consumption: 22.5 Nm<sup>3</sup>/h,  
 atomization air pressure: 5.0 bar (g)

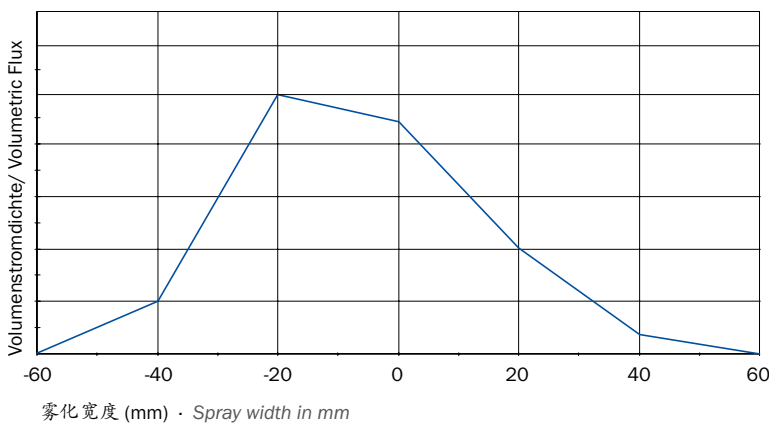

**Volume density of Mod. 943/0**

Spray width: 120 mm, distance: 200 mm,  
 liquid throughput: 70 l/h, liquid pressure: 0.1 bar ( $\Delta p$ )  
 atomization air consumption: 22.5 Nm<sup>3</sup>/h,  
 atomization air pressure: 5.0 bar (g)

# 客户定制设计 Customized Designs

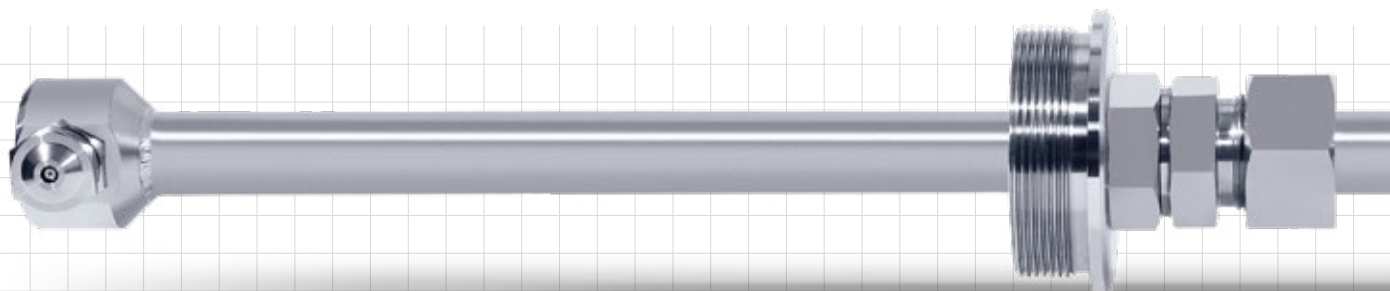

型号940 S152

含枪杆的直角两流体喷嘴，  
伸进设备的长度可调节

*Angled two-substance lances with  
adjustable immersion depth.*

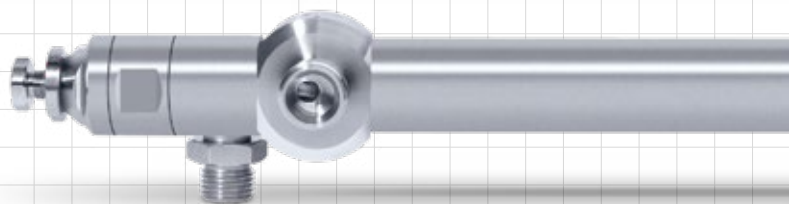

Mod. 940



型号940 S152

直角设计，压盖机械密封、  
法兰固定，杆子长度和附件可  
依据客户要求调整

*With angle piece (90° angle), gland  
seal and mounting flange; variable  
total length and attachment options.*

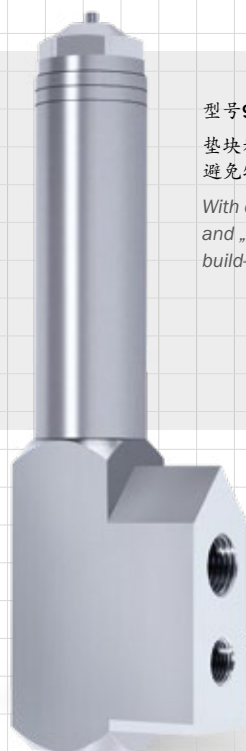

型号940 0 S36

垫块和风帽形成光滑的屋顶状，  
避免物料的堆积

*With distancing rings on the air cap  
and „roof-shaped“ units to avoid  
build-up of deposits.*

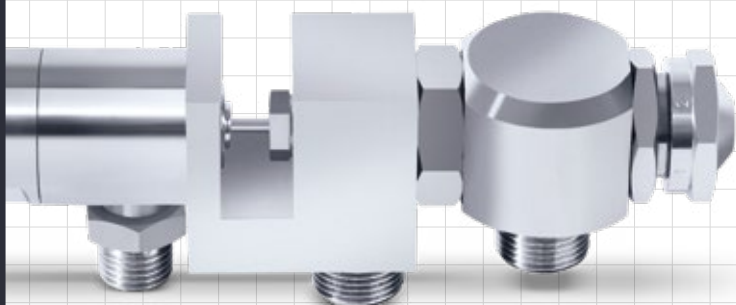

型号940 7-1 S84

采用高压密封或自动针形密封，针阀控制气体  
和雾化单元物理隔绝，避免密封圈破损时，  
液体流到气路中

*With high-pressure seal or autarkic needle  
seal, i.e. the controlling air duct is physically  
separated from the atomization unit.*



型号940 0 S25

垫块和风帽形成光滑的屋顶状，通过两侧  
螺纹，喷嘴可以直接固定在杆子上。

*With distancing rings on the air cap  
and clamping on the shaft.*

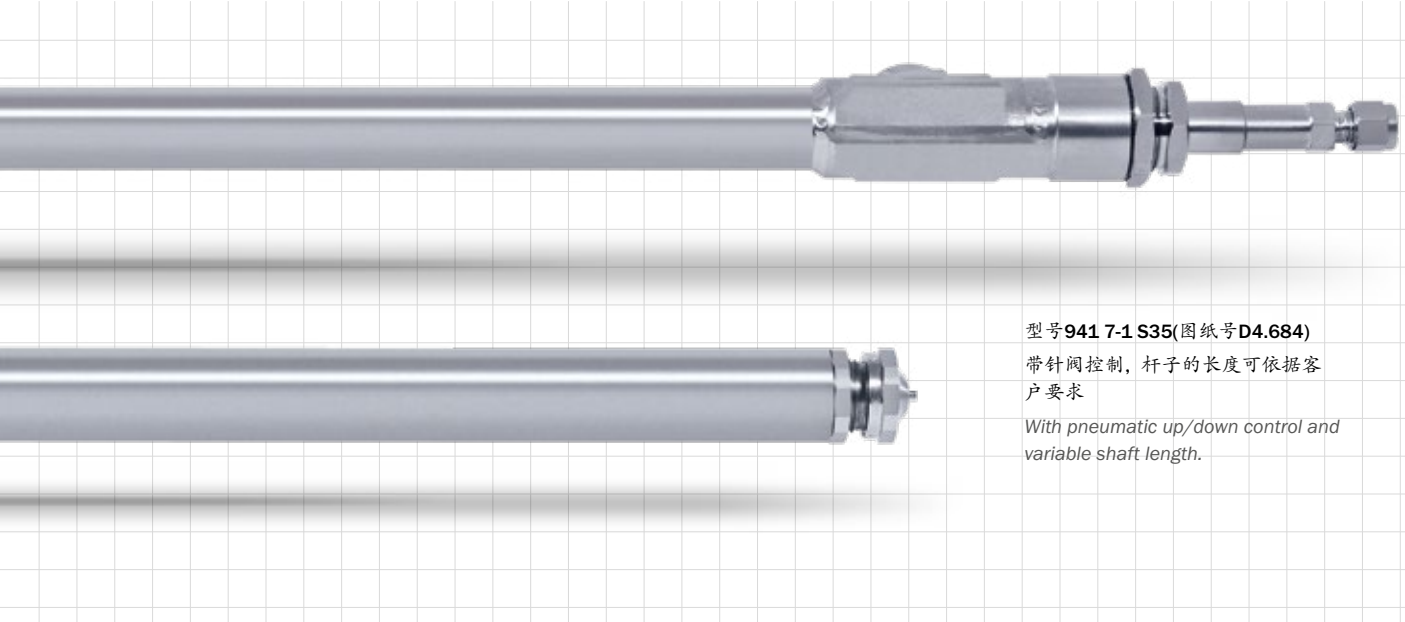

型号941 7-1 S35(图纸号D4.684)

带针阀控制, 杆子的长度可依据客户要求

With pneumatic up/down control and variable shaft length.

## 单件或者小批客户定制

作为一家全球领先的喷嘴制造商, SCHLICK一直为客户提供高质量的标准解决方案

当然, 凭借高精度的制造能力以及丰富的研发经验, SCHLICK也可根据客户特殊要求进行设计开发。

即使客户的需求量少, 交期紧。

## Custom and individual designs, small series

As a leading nozzle manufacturer, high quality standardised solutions are business-as-usual for SCHLICK.

However, thanks to the breath of its manufacturing capacities and comprehensive expertise, SCHLICK can also produce custom and individual designs for specific applications.

No matter how small the series or short the timeframe.

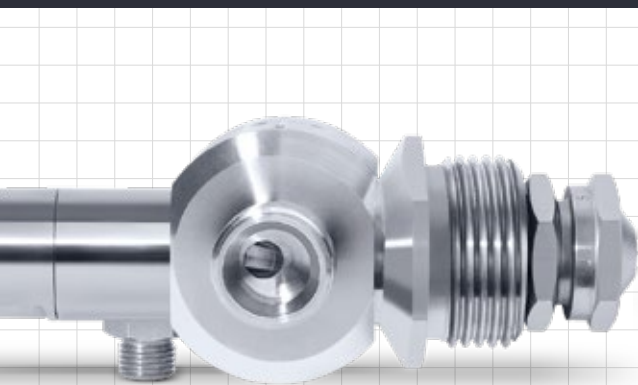

型号970 7-1 S2

定制型号, 带螺纹, 用来将喷嘴固定到盖子或者设备内壁上等位置

Custom model with screw thread for screwing into cover, walls, etc.



型号948 7-1 S4

用来雾化高粘度流体, 带加热夹套、带有液滴回收功能、喷嘴本身带清洁顶针

For spraying highly viscous media; with integrated heating jacket, liquid supply and return system, and nozzle with cleaning needle.

产品目录  
Product Overview

两液体喷嘴  
Two-Substance  
Nozzles

防飞溅/差速流体材料技术  
ABC/PCA Technique

三/四液体喷嘴  
Three-/Four-

多喷头技术  
Multispray

喷嘴杆  
Insertion Pipes

喷嘴头  
Nozzle Heads

空心锥喷嘴  
Full-Cone Nozzles

空心锥喷嘴  
Hollow-Cone Nozzles

硬质合金喷嘴  
Carbide Nozzles

扁平喷嘴  
Flat Spray Nozzles

喷射喷嘴  
Smooth-Jet Nozzles

混合喷嘴  
Mixing Nozzles

拉瓦尔喷嘴  
Laval Nozzles

清洁喷嘴  
Cleaning Nozzles

喷嘴附件  
Accessories  
测试中心  
Test Center